

### PULL HANDLES

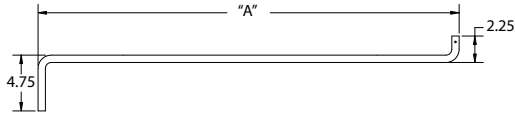

Part Number	Dim A	Application
16966	32.85"	GREAT DANE MODEL B
16967	35.85"	

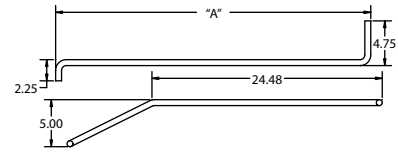

Part Number	Dim A	Application
13409	33.50"	GREAT DANE MODEL H

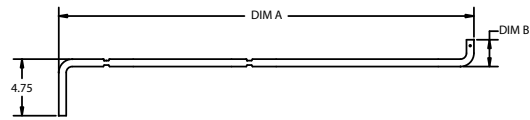

Part Number	Dim A	Dim B	Application
40302103	34.85"	2.25"	GREAT DANE
SL0744-07	34.50"	1.88"	BINKLEY LITE SLIDE

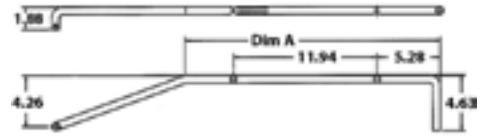

Part Number	Dim A	Application
SLOA1122-48	24.25"	HOLLAND BINKLEY AIRLITE

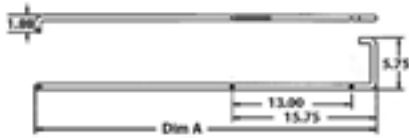

Part Number	Dim A	Application
SLOA1269-01	37.25"	HOLLAND BINKLEY ULTRALITE 2

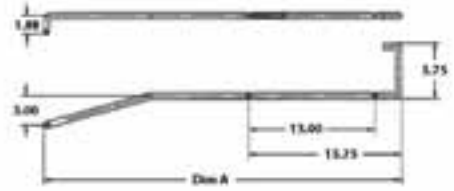

Part Number	Dim A	Application
SLOA1445-01	37.25"	HOLLAND BINKLEY CB400/4000



Part Number	Dim A	Application
19468	34.57"	HUTCH 9801/9811

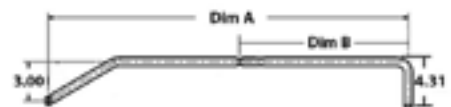

Part Number	Dim A	Dim B	Application
8518-00	28.00"	16.67"	HUTCH 8500
8518-03	28.00"	15.12"	HUTCH 9000

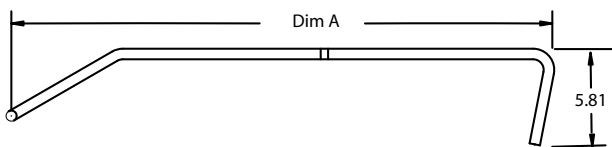

Part Number	Dim A	Application
18010-01	31.96"	HUTCH 9802
18010-02	29.96"	HUTCH 9200

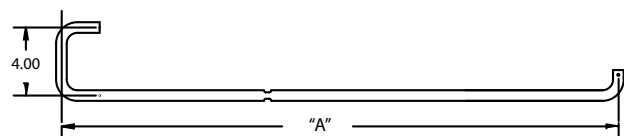

Part Number	Dim A	Application
12781-01	37.25"	HUTCH 8200

## QUICK RELEASES

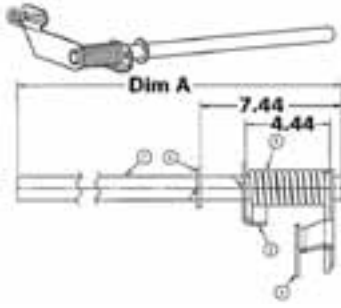

Part Number	Dim A	Application
SLOA1277-01	29.00"	HOLLAND BINKLEY NEWLITE

Part Number	Description
SLO724-42	HOLLAND BINKLEY QUICK RELEASE 96" TRAILER
SLO724-48	HOLLAND BINKLEY QUICK RELEASE 102" TRAILER

1

2

3

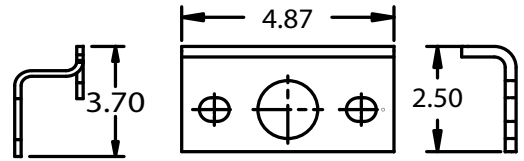
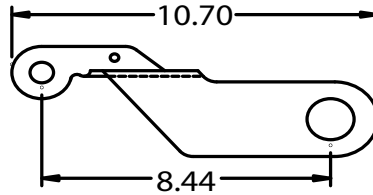
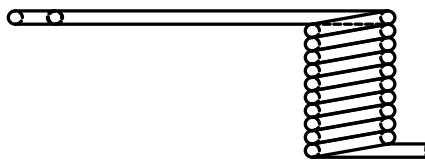

Item	Part Number	Description
1	SLO258	TORSION SPRING

Item	Part Number	Description
2	SLO369-01	TORSION LEVER ARM

Item	Part Number	Description
3	SLO758-01-PTD	TORSION CAM

## SLIDER HOLD DOWNS



Part Number	Description
12715-01	BODY RAIL CLIP HUTCH 9200

Part Number	Description
20289-01	BODY RAIL CLIP HUTCH 9800 SERIES

Part Number	Description
8505-00	BODY RAIL CLIP HUTCH 8500



Part Number	Description
90015150	BODY RAIL CLIP BINKLEY

Part Number	Description
S-14108	BODY RAIL CLIP OLD STYLE 1.5" HOLE CENTERS
S-22366	BODY RAIL CLIP NEW STYLE 2" HOLE CENTERS

Part Number	Description
S-24460	BODY RAIL CLIP VANTRAAX & K-2 SLIDES

## SLIDE RAIL REINFORCEMENTS



Part Number	Description
40103601	SLIDE RAIL REINF BRACKET (H-SLIDE)



Part Number	Description
40100294	SLIDE RAIL REINFORCEMENT (B-SLIDE)

## SLIDER PADS



Part Number	Description
12818-01	SLIDE PAD .25" X 4.00" X 5.50" HUTCH 8500 & 9000



Part Number	Description
3-16-38	.25" X 2.00" X 95.75" (TRAILMOBILE)
11421-01	.25" X 2.00" X 96.00" (HUTCH)
40301105	.25" X 2.00" X 100.00" (GREAT DANE)